



PRODUCT CATALOGUE

2022

ALUMINUM GLAZING AND PROFILE SYSTEMS FOR FINEST BUILDINGS IN INDIA

www.yuuup.in

MODULAR FIXED GLASS PARTITION SYSTEM

Demountable

Relocatable

Modular

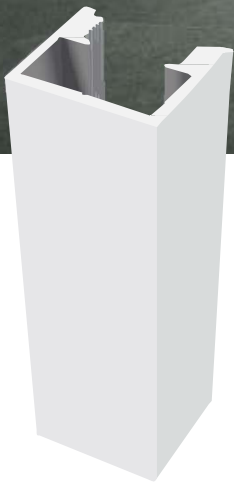

SINGLE GLAZE

Partition System 25mm

The Pint demountable office partition system can be equipped with strong acoustic insulation for more relaxing atmosphere within the large office space. It can be used with glass to glass dry joints including flush aluminium.

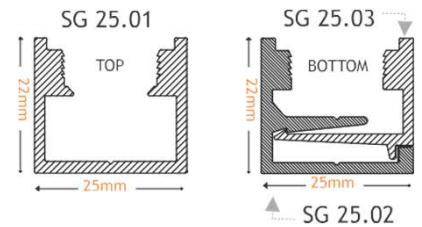

- Standard track section : 25mm x 22mm
- Slim in design, the standard partition suite can be used with any stud thickness.
- Comfortable glass thickness of 10mm to 12mm.
- Single glazed system.
- Sound insulation capacity of 32 - 36 dB.

Technical Specifications

Material	Aluminium
Surface Finish	Anodized / Powder Coated / SS Finish
Length Size	2600 mm / 3600 mm
Standard Size	25 x 22 mm
Gauge	2 mm (approx)
Coating Thickness	Anodized - 15-20 Microns (Avg.)
	Powder Coated - 50-70 Microns (Avg.)
Installation	Screw Fixing



CHOOSE THE RIGHT PROFILE BASED ON YOUR APPLICATION



EASY CARE AND MAINTENANCE



EASY INSTALLATION

MORE COLORS AVAILABLE

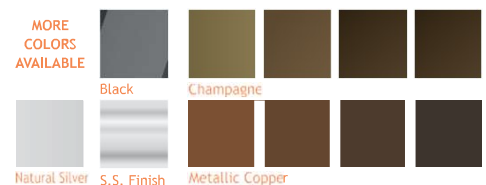



SINGLE GLAZE

Partition System 45mm

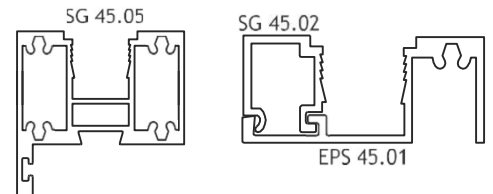
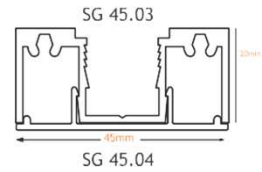

The Premium demountable office partition is a superior lightweight profile system. It is based on a 45 mm x 20 mm glazing seal and bead with a selection of door frame options. Premium frame provides an elegant and cost effective design solution.

- Standard track section : 45mm x 20mm
- Slim in design, the standard partition suite can be used with any stud thickness.
- Comfortable glass thickness of 10mm to 12mm.
- Single door frame size to allow for flush door of 40mm-42mm.
- Single glazed system.
- Sound insulation capacity of 28 - 32 dB.

Technical Specifications	
Material	Aluminium
Surface Finish	Anodized / Powder Coated / SS Finish
Length Size	2600 mm / 3600 mm
Standard Size	45 x 20 mm
Gauge	2 mm (approx)
Coating Thickness	Anodized - 15-20 Microns (Avg.)
	Powder Coated - 50-70 Microns (Avg.)
Installation	Screw Fixing



CHOOSE THE RIGHT PROFILE BASED ON YOUR APPLICATION



EASY CARE AND MAINTENANCE



EASY INSTALLATION

MORE COLORS AVAILABLE

Natural Silver



Black

Champagne

Natural Silver

S.S. Finish

Metallic Copper



SINGLE GLAZE

Partition System 75mm

The Ultra demountable office partitions. It is based on a 75mm x 20mm glazing seal and bead with a selection of door frame options.

- Standard track section : 75mm x 20mm
- Slim in design, the standard partition suite can be used with any stud thickness.
- Comfortable glass thickness of 10mm to 12mm.
- Single door frame size to allow for flush door of 40mm or 42mm.
- Single glazed system.
- Sound insulation capacity of 32 - 34 dB.

Technical Specifications

Material	Aluminium
Surface Finish	Anodized / Powder Coated / SS Finish
Length Size	2600 mm / 3600 mm
Standard Size	75 x 20 mm
Gauge	2 mm (approx)
Coating Thickness	Anodized - 15-20 Microns (Avg.) Powder Coated - 50-70 Microns (Avg.)
Installation	Screw Fixing

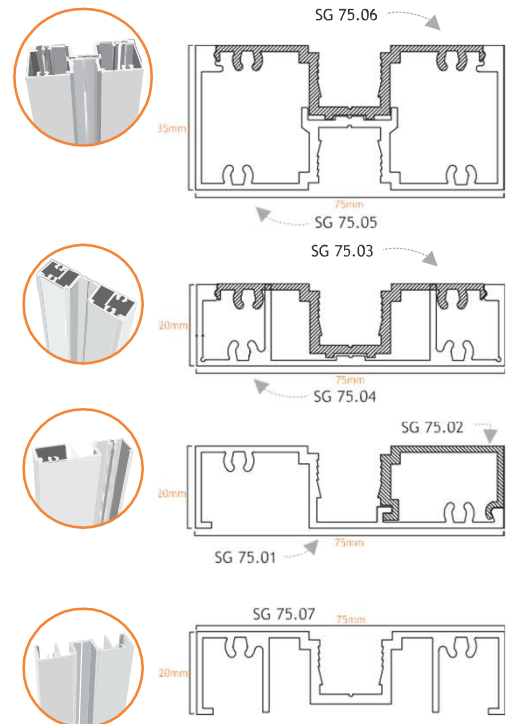

MORE
COLORS
AVAILABLE

Black

Champagne

Natural Silver

S.S. Finish

Metallic Copper



CHOOSE THE RIGHT
PROFILE BASED ON
YOUR APPLICATION



EASY CARE AND MAINTENANCE



EASY INSTALLATION



SINGLE GLAZE

Partition System 100mm

The Ultra-Strong demountable office partition. It is based on a 102mm x 20mm glazing seal and bead with a selection of door frame options.

- Standard track section : 102mm x 20mm
- Slim in design, the standard partition suite can be used with any stud thickness.
- Comfortable glass thickness of 10mm to 12mm.
- Single door frame size to allow for flush of door of 40mm or 42mm.
- Single glazed system.
- Sound insulation capacity of 32 - 34 dB.

Technical Specifications

Material	Aluminium
Surface Finish	Anodized / Powder Coated / SS Finish
Length Size	2600 mm / 3600 mm
Standard Size	102 x 20 mm
Gauge	2 mm (approx)
Coating Thickness	Anodized - 15-20 Microns (Avg.)
	Powder Coated - 50-70 Microns (Avg.)
Installation	Screw Fixing

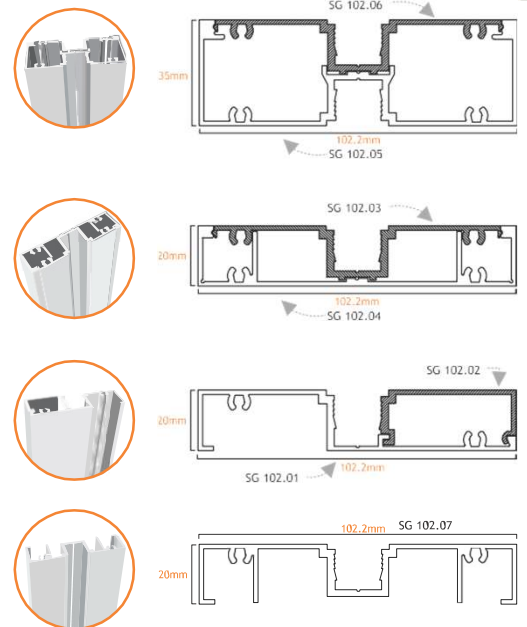

CHOOSE THE RIGHT PROFILE BASED ON YOUR APPLICATION



EASY CARE AND MAINTENANCE



EASY INSTALLATION

MORE COLORS AVAILABLE

Black

Natural Silver

S.S. Finish

Metallic Copper



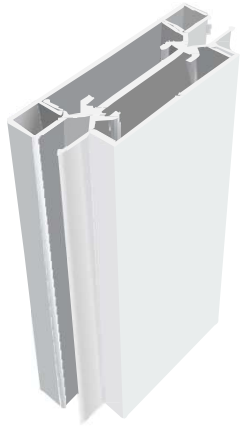

DOUBLE GLAZE

Partition System 80mm / 100mm

The Ultra Max demountable office partition provides excellent acoustic values. It is based on a 80 x 30 mm glazing seal and bead with a selection of door frame options.

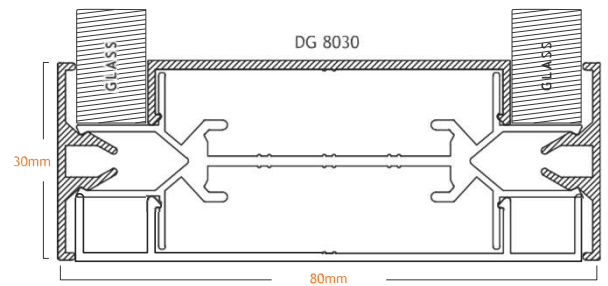

- Standard track section : 80mm x 30mm
- Slim in design, the standard partition suite can be used with any stud thickness.
- Comfortable glass thickness of 10mm
- Partition height offered upto 3000mm.
- Double glazed system.
- Sound insulation capacity of 38 - 42 dB.

Technical Specifications

Material	Aluminium
Surface Finish	Anodized / Powder Coated / SS Finish
Length Size	3000 mm
Standard Size	80 x 30 mm
Gauge	2 mm (approx)
Coating Thickness	Anodized - 15-20 Microns (Avg.)
	Powder Coated - 50-70 Microns (Avg.)
Installation	Screw Fixing



CHOOSE THE RIGHT PROFILE BASED ON YOUR APPLICATION



EASY CARE AND MAINTENANCE



EASY INSTALLATION

MORE COLORS AVAILABLE





STILE DOORS

45mm x 75mm Stile Door

The Stile frame door accommodates standard door hardware including concealed closer and drop down seals if required. This door can be used with ULTRA-MAX series and ULTRA-STRONG series.

- Standard track section : 75mm x 45mm
- Comfortable glass thickness of 10mm
- Door height offered upto 2600 mm.
- Single glazed stile door systems.
- Sound insulation capacity of 32 - 36 dB.

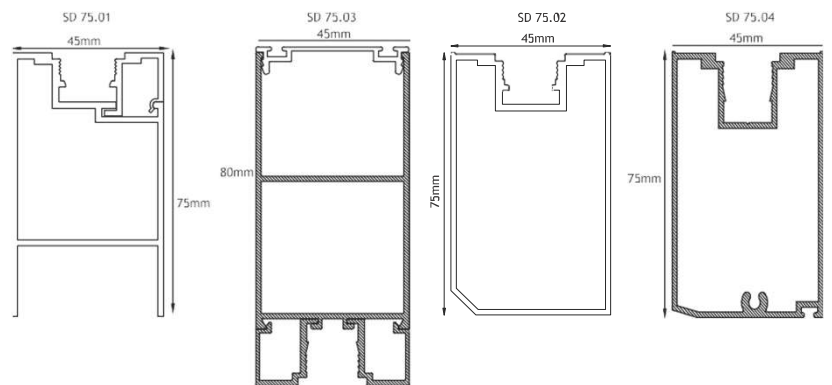

Technical Specifications

Material	Aluminium
Surface Finish	Anodized / Powder Coated
Length Size	2600 mm
Width Size	75 mm
Coating Thickness	Anodized - 15-20 Microns (Avg.)
	Powder Coated - 50-70 Microns (Avg.)
Installation	Screw Fixing



CHOOSE THE RIGHT PROFILE BASED ON YOUR APPLICATION



EASY CARE AND MAINTENANCE



EASY INSTALLATION

MORE COLORS AVAILABLE





DOOR STOPPER SERIES & GLASS PROFILE

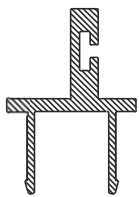

DS 01
Door stop
35mm Door stop
in 75 Series
45mm Door stop
in 100 Series

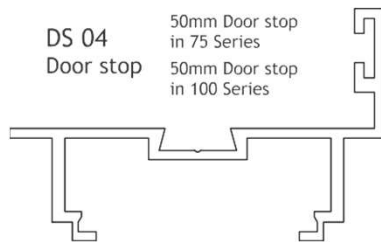

DS 04
Door stop
50mm Door stop
in 75 Series
50mm Door stop
in 100 Series

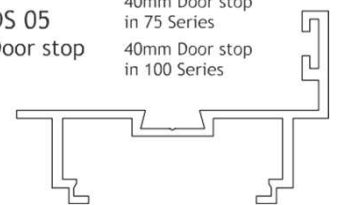

DS 05
Door stop
40mm Door stop
in 75 Series
40mm Door stop
in 100 Series

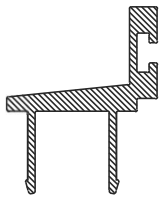

DS 02
Door stop
35mm Door stop
in 100 Series

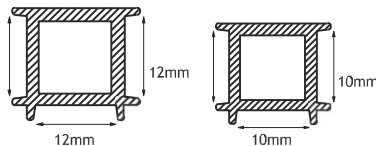

T PROFILE

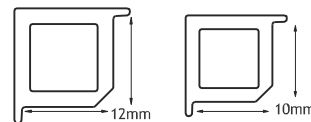

L PROFILE

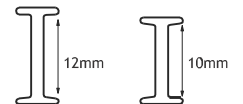

I PROFILE

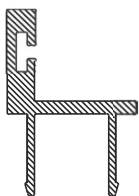

DS 03
Door stop
45mm Door stop
in 75 Series

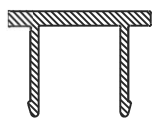

DUMMY

Technical Specifications	Door Stop	Profiles
Material	Aluminium	
Surface Finish	Anodized / Powder Coated	
Length Size	2600/3600 mm	2745 mm
Coating Thickness	Anodized - 15-20 Microns (Avg.)	
	Powder Coated - 50-70 Microns (Avg.)	
Installation	Screw / Adhesive Fixing	



CHOOSE THE RIGHT
PROFILE BASED ON
YOUR APPLICATION



EASY CARE AND MAINTENANCE



EASY INSTALLATION

MORE
COLORS
AVAILABLE



Black

Champagne



Natural Silver

S.S. Finish

Metallic Copper

HARDWARE ACCESSORIES

EGL-1001-AL
Glass Door Hinge



EEC-001
Euro
Cylinder



EGHL-1001-SS
Glass Door Handle with Lock



EGL-1001-AL
Glass Door Hinge



EGL-1001-AL
Glass Door Hinge



EOPH
Glass Door Hinge



EBL-101-AL
Glass Bottom Lock



EDC- 3000
Door closer for leaf widths of up to 1100 mm





Contacts:

CI Modular Systems Pvt. Ltd.
F-90/23, Okhla Industrial Area, New Delhi 10020
contact@niveeta.com

(M) +91 9911227763/4

www.yuuup.in